

PLANTA PAVIMENTO TÉRREO
ESCALA 1:100

ÁREA = 676,46 m².

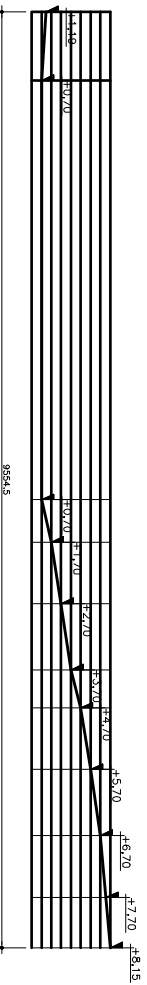

PERFIL LONGITUDINAL
ESCALA 1:300

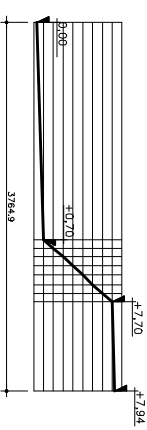

PERFIL TRANSVERSAL
ESCALA 1:300

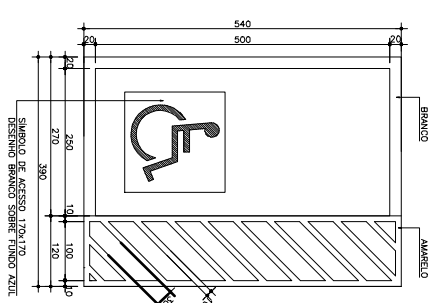
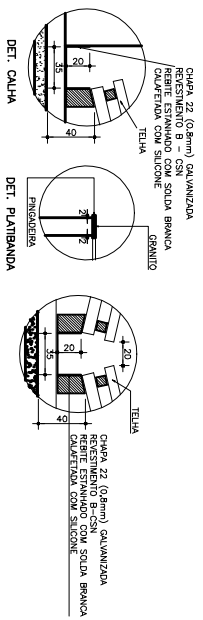
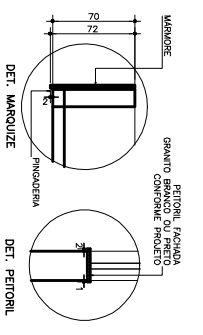

DETALHE VAGA VEÍCULO CREDENCIADO
ESCALA 1:50

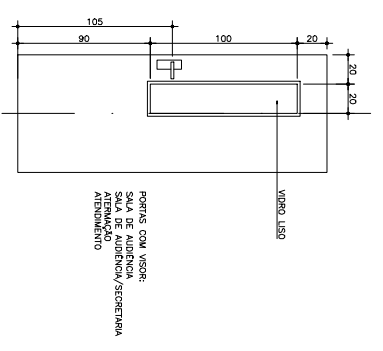

DET. PORTAS
ESCALA 1:25

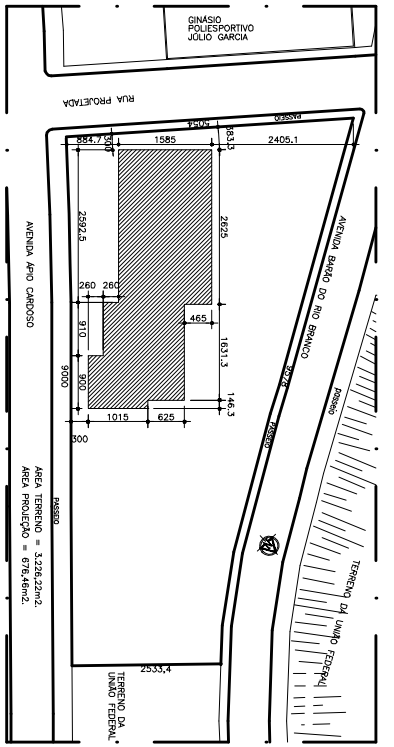

SITUAÇÃO
ESCALA 1:300

JANELAS

J1	60x90	m=140
J2	60x120	m=100
J3	80x140	m=100
J4	80x140	m=100
J5	80x110	m=90

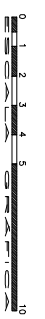

PROJETO ARQUITETÔNICO		01/02	
DATA: 19/03/2011			
DES: SARKIS			
PLANTA PAV. TÉRREO, SITUAÇÃO, PERFS DO TÉRREO			
PROPR.: TRIBUNAL REGIONAL DO TRABALHO - 3ª REGIÃO			
LOCAL: AV. APO CARROSSO - S/N - CENTRO			
SITUAÇÃO: VZE FRANÇA			
ZONA: ZR-1			
ÁREAS: (m ²)			
PAV. TÉRREO	652,20		
ÁREA TÉRRENO	3228,22		
ÁREA PROTEÇÃO	676,46		
VISTOS:			
AUTOR DO PROJETO:		HOSAN LUIZ GUARANDA	
PROFESSOR:		HOSAN LUIZ GUARANDA	
REVISOR:		HOSAN LUIZ GUARANDA	
AUTOR DO PROJETO:		HOSAN LUIZ GUARANDA	
PROFESSOR:		HOSAN LUIZ GUARANDA	
REVISOR:		HOSAN LUIZ GUARANDA	